

SUGGESTED PCB LAYOUT
TOP VIEW

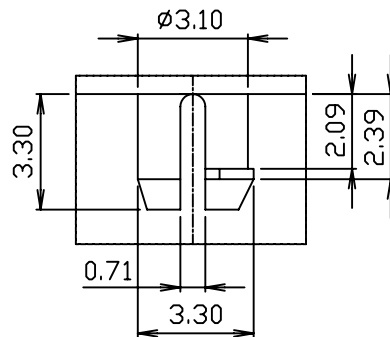

DETAIL X

XRJK-U-01-6-6-0-9K1

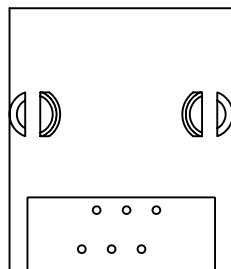
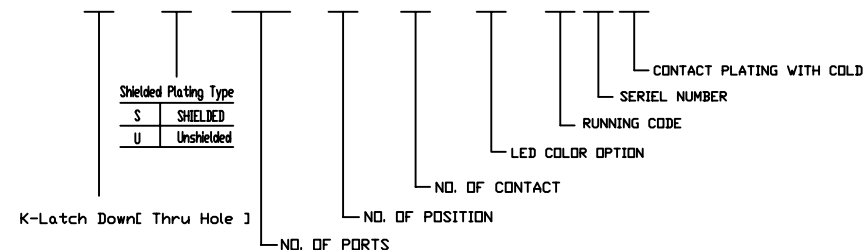

NOTES:

- MATERIALS:
HOUSING-PBT POLYESTER UL94V-0
MIXED GLASS FIBER.
STANDARD COLOR-BLACK
CONTACTS-0.45mm DIA. ROUND PHOS-BRONZE
PLATED WITH 15u" GOLD.
- CAVITY CONFIRMS TO FCC RULES AND REGULATIONS
PART 68,SUBPART F.
- UNSPECIFIED TOLERANCE: .XX ±0.25
.X ±0.30

RoHS Compliant

X MULTIPLE		CONNECTING THE INFORMATION AGE	
XMULTIPLE ASIA 4F, No. 347, Yang Guang St., Neihu Chu, Taipei, Taiwan 11475		XMULTIPLE USA 1420 Los Angeles Ave., Suite G, Simi Valley, CA 93065	
THIS DRAWING IS A CONTROLLED DOCUMENT.		G/ND:	
TITLE: RJ11 Connectors, W/D LED, 6P,6C, Unshielded, Thru-Hole		DWG NO: XRJK-U-01-6-6-0-9K1	
PART NO: XRJK-U-01-6-6-0-9K1		DRAWN: TARA	
		CHKD: JEFF	
		DATE: Dec.05,05	
UNIT mm[inch]	SHEET 1 of 1	REV 01	