

1. MECHANICAL DIMENSIONS :

NOTES:

1. RJ45 MECHANICAL:
 PLASTIC HOUSING: THERMOPLASTIC PBT BLACK
 FLAMMABILITY RATING UL 94V-0
 FRONT CONTACT: PHOSPHOR-BRONZE T=0.35mm±0.01
 50u' GOLD PLATING ON CONTACT AREA,
 OVER 50u' NICKEL PLATING ON ALL AREA,
 WITH 100u' TIN PLATING ON SOLDER AREA.
 BACK CONTACT: BRASS T=0.40mm±0.01
 50u' NICKEL PLATING ON ALL AREA,
 WITH 100u' TIN PLATING ON SOLDER AREA.
 SHIELD: BRASS T=0.20mm±0.01
 50u' NICKEL PLATING ON ALL AREA,
 SOLDERABILITY: PER MIL STD. 202, METHOD 208.
 DURABILITY: 750 MATING CYCLES MIN.

2. USB 2.0 B TYPE CONNECTOR / 164-20426**
 BY e-CONN ELECTRONIC CO, LTD.
 COMPLIANCE TO USB 2.0 HI-SPEED
 TID: 60000389
 3. USB MECHANICAL:
 HOUSING: HIGH TEMP. THERMOPLASTIC
 BLACK, UL 94V-0
 CONTACT: PHOSPHOR-BRONZE T=0.25mm±0.01
 30u' GOLD PLATING ON CONTACT AREA,
 OVER 50u' NICKEL PLATING ON ALL AREA,
 WITH 100u' TIN PLATING ON SOLDER AREA.
 SHIELD: BRASS T=0.30mm±0.01
 100u' TIN PLATING ON SOLDER AREA,
 OVER 50u' NICKEL PLATING ON ALL AREA.
 MATING FORCE: 35 NEWTONS MAXIMUM
 UNMATING FORCE: 10 NEWTONS MINIMUM
 DURABILITY: 1500 MATING CYCLES MIN.
 4. UNSPECIFIED TOLERANCE: .XX ±0.25[0.01]
 X ±0.30[0.012]

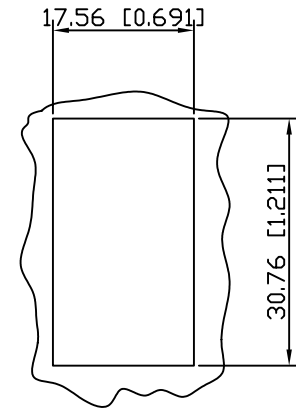
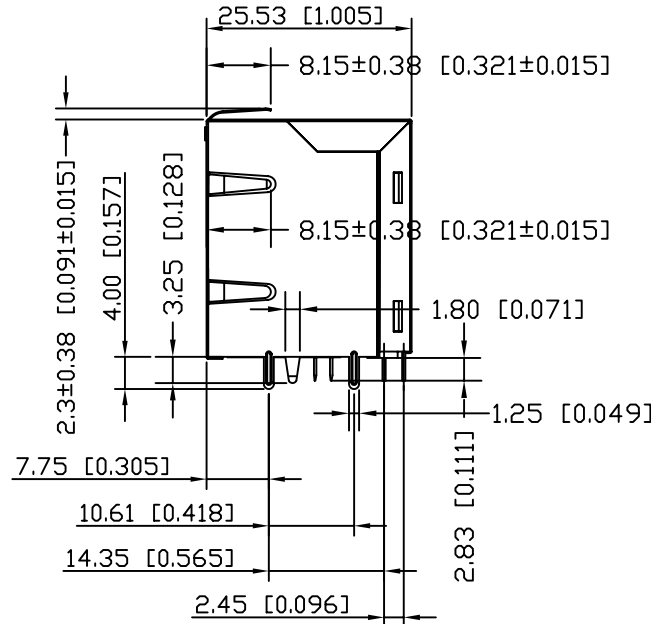
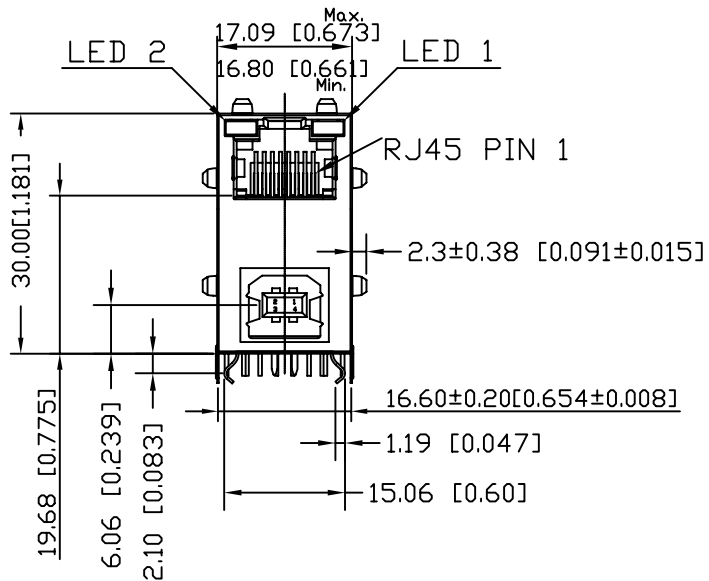

XRJB-B60-X-DA1-01

PRODUCT SERIES
 B : RJ45 OVER USB

NUMBER OF PORT
 B60 : RJ45 OVER USB B TYPE

LED COLOR OPTION

CIRCUIT TYPE

SERIAL NUMBER

RoHS Compliant

		CONNECTING THE INFORMATION AGE	
		CUSTOMER/NO:	
X MULTIPLE ASIA 4F, No. 347, Yang Guang St., Neihu Chiu, Taipei, Taiwan 11475		X MULTIPLE USA 1420 Los Angeles Ave., Suite G, Simi Valley, CA 93065	
THIS DRAWING IS A CONTROLLED DOCUMENT.			
TITLE: RJ45+USB B Type, w/LED,w/Filter 10/100 Mbps 8P,6C,Shielded,Thru-Hole			
PART NO:		XRJB-B60-X-DA1-01	
		UNIT	SHEET
		mm[inch]	1 of 3
		REV	01
		DATE:	25/10/05

A
B
C
D
E
F

A
B
C
D
E
F

2. PCB LAYOUT :

3. LED CONFIGURATION :

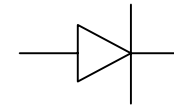
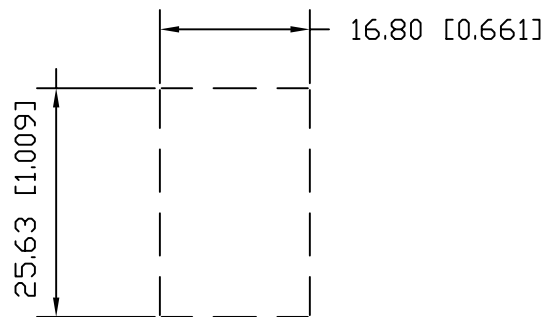
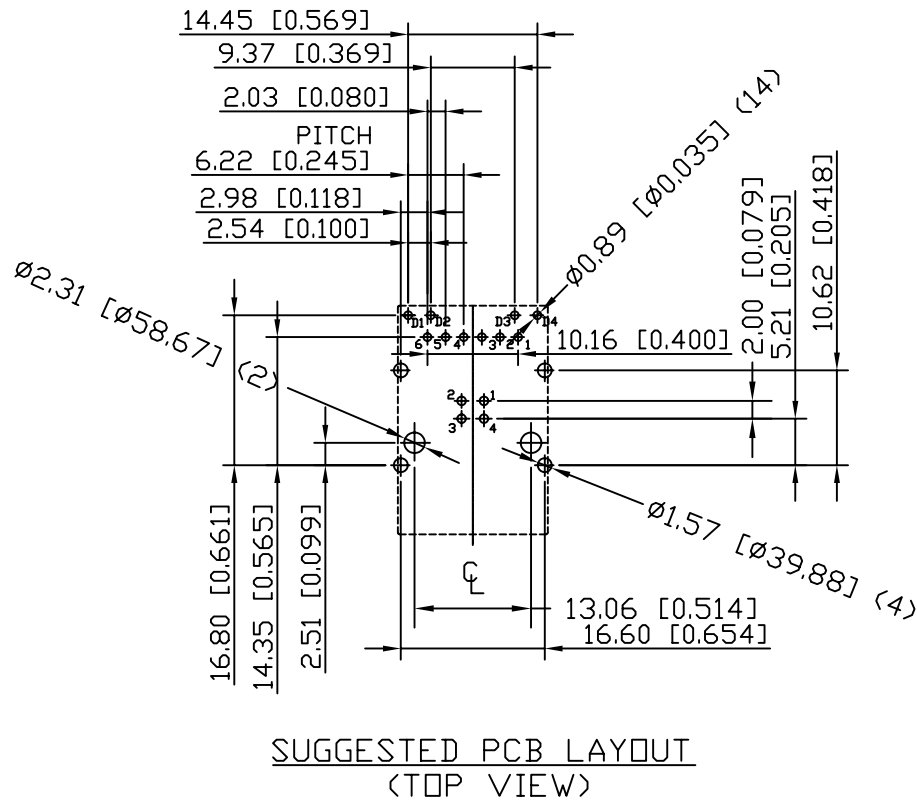

SINGLE-COLOR LED

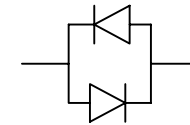

BI-COLOR LED

Color	Lens Color	Vf(v) @20mA		Iv(mcd) @10mA		Viewing angle
		Min	Max	Min	Typ	
						2θ 1/2

RoHS Compliant

		CONNECTING THE INFORMATION AGE		CUSTOMER/NO:	
				MULTIPLE ASIA 4F, No. 347, Yang Guang St., Neihu Chiu, Taipei, Taiwan 11475	
THIS DRAWING IS A CONTROLLED DOCUMENT.					
TITLE: RJ45+USB B Type, w/LED,w/Filter 10/100 Mbps 8P,6C,Shielded,Thru-Hole					
PART NO: XRJB-B60-X-DA1-01					
		UNIT	SHEET	REV	DATE
		mm[inch]	2 of 3	01	25/10/05

4. SCHEMATIC:

CONNECTOR SOLDER SIDE

RJ45 CONTACT SIDE

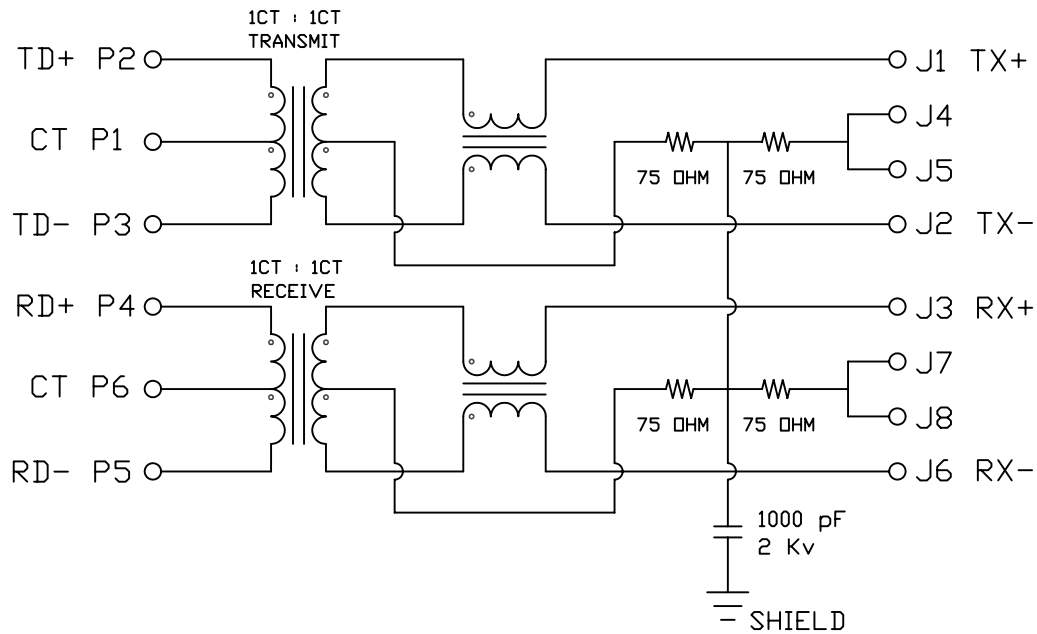

5. ELECTRICAL CHARACTERISTICS :

TEST NOTES:(25±5°C)

1.TR:(100KHz,0.1V);

PINS:(P2-P3):(J1-J2)=1:1±3%

PINS:(P4-P5):(J3-J6)=1:1±3%

2.LX:(100KHz,100mV,8mA, DC Bias)

PINS: (P2,P3),(P4,P5)=350uH MINIMUM

3.DCR:

PINS:(P2-P3),(J1-J2),(J3-J6)= 1.0 OHMS MAXIMUM

PINS:(P4-P5)=1.2 OHMS MAXIMUM

4.HIPOT:

PINS(P2,P1,P3)TO(J1,J2)=1500VAC FOR 60 SECONDS

PINS(P4,P6,P5)TO(J3,J6)=1500VAC FOR 60 SECONDS

5.INSERTION LOSS:

-1.0dB MAXIMUM AT 0.3MHz TO 100MHz;

6.RETURN LOSS:

-20dB MINIMUM AT 1MHz TO 30MHz;

-15dB MINIMUM AT 30MHz TO 60MHz

-10dB MINIMUM AT 60MHz TO 80MHz

7.CROSS TALK:

-30dB MINIMUM AT 1MHz TO 100MHz

8.COMMON TO COMMON MODE REJECTION:

-30dB MINIMUM AT 1MHz TO 100MHz

RoHS Compliant

X MULTIPLE		CONNECTING THE INFORMATION AGE	
X MULTIPLE ASIA 4F, No. 347, Yang Guang St., Neihu Chiu, Taipei, Taiwan 11475		X MULTIPLE USA 1420 Los Angeles Ave., Suite G, Simi Valley, CA 93065	
CUSTOMER/NO:			
THIS DRAWING IS A CONTROLLED DOCUMENT.			
TITLE: RJ45+USB B Type, w/LED,w/Filter 10/100 Mbps 8P,6C,Shielded,Thru-Hole			
PART NO: XRJB-B60-X-DA1-01			
UNIT		SHEET	
mm[inch]		3 of 3	
REV		DATE:	
01		25/10/05	